



High power radio transmission module MR03 type



User's manual



CONTENTS

1.APPLICATION	3
2.MR03 MODULE SET	4
3.INSTALLATION	4
3.1 Module assembly	4
3.2 Connection diagrams	5
3.3 Connection way with devices	5
3.4 Requirements for lead connections	6
4.PRINCIPLE OF OPERATION OF MR03 MODULE	6
4.1 First start of MR03 module	7
4.1.1 <i>Installation of the configuration program on a PC</i>	7
4.1.2 <i>Procedure of the MR03 module configuration</i>	7
4.1.3 <i>Way of the received power signal measurement - RSSI</i>	9
4.1.4 <i>List of displayed errors in the systemic window</i>	10
4.1.5 <i>Prescription concerning radio transmission or sending-receiving devices which can be used without permission</i>	11
5.TECHNICAL DATA	12
6.ORDER CODES	13
7.MAINTENANCE AND WARRANTY	13

1. APPLICATION

The MR03 high power radio transmission module is destined to change the information transmission medium from the cable transmission with RS-232 and RS-485 interface into a wireless transmission in the radio channel in the non-licensed band 869.4 – 869.65 MHz with the output power 500 mW.

The module MR03 finds application in telemetric system applications, in which there is no technical possibilities to conduct a cable to connect devices in a wired network. In such cases, the module is used as a bridge which partially will carry out the transmission through the radio way.

The maximal operation range of the MR03 module is 1.5 km in average, and depends on the terrain configuration and the applied antenna.

Accessible MR03 working modes allow to the individual communication of MR03 module pairs ("point-to-point" mode) and broadcasting communication ("point-to-many points" mode). Necessary parameter changes to the correct module work are carried out by means of the added configuration program MR03Config.exe.

An exemplary MR03 module application is presented on the fig. 1..

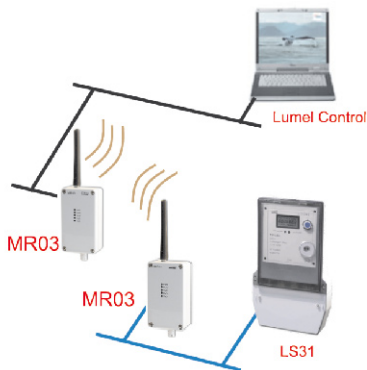

Fig 1. Exemplary remote readout of LS31 watt-hour using the MR03 module

2. MR03 MODULE SET

The set of the MR03 module is composed of:

- MR03 module 1 pc.
- Stub antenna with SMA connector 1 pc.
- Antenna wire 1 pc.
- MR03 user's manual 1 pc.
- warranty card 1 pc.
- mini CD with software 1 pc.

When unpacking the module, please check whether the type and execution code on the data plate correspond to the order.

3. INSTALLATION

Symbols located in this user's manual mean:



WARNING!

Warning of potential, hazardous situations. Especially important. One must acquaint with this before connecting the module.

The non-observance of notices marked by these symbols can occasion severe injuries of the personnel and the damage of the module.



CAUTION!

Designates a general useful note. If you observe it, handling of the transducer is made easier. One must take note of this, when the instrument is working inconsistently to the expectations.

Possible consequences if disregarded!

3.1. Module assembly

One can fix the module on a wall or a construction by means of a screw or glue without the lost of the tightness class IP54. The housing is made of a self-extinguishing plastic.

The fixing of the module by means of a screw connection is carried out through fixing holes shown on the fig. 2. The access to holes is possible after removing the upper part of the MR03 module housing.

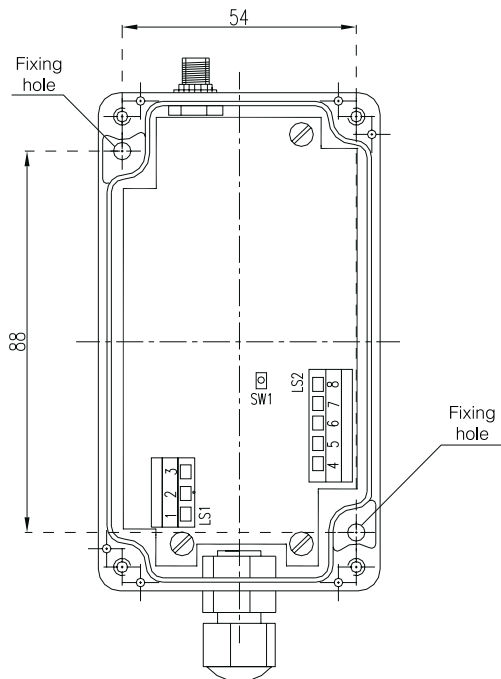

Fig. 2 Assembly drawing

3.2. Electrical connections of MR03 module

The supply and external signals must be connected in compliance with the drawing 3 and table 1, in which the assignment of individual leads of the MR03 module are described.





3.3. Connection way with devices

The connection way of the MR03 module to RS-232 or RS-485 interfaces is presented on fig. 4 and 5.

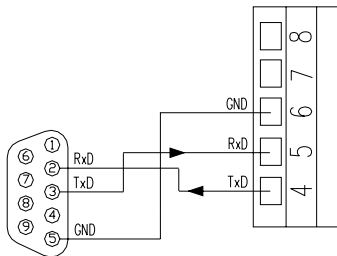

*Fig. 4
Connection way of The MR03
module to the RS-232 bus*

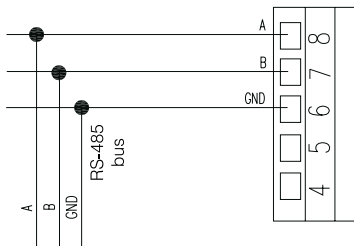

*Fig.5.
Connection way of MR03
module to the RS-485 bus.*



Caution:

Because of electromagnetic interference, one must use shielded wires to connect signals of the RS-485 interface. The shield must be connected to the earthing terminal in one point. The supply must be connected by a two-wire cable of appropriate wire diameter. It is recommended to use an additional protection in the shape of a fusible cut-out.



3.4. Requirements for lead connections

Different interference sources practically occurring, interact with the module in a continuous or pulsing way from the supply network side (because of other device actions).

The level of this interference should be reduced to a value lower than the module fastness threshold, first of all through the appropriate installation of the module in the object.

In order to obtain a full module resistance against electromagnetic interference in an environment of unknown interference level, it is recommended to observe following principles:



- do not supply the module from the network, near devices producing high pulse interference,
- apply network filters for a group of modules servicing the same object,
- apply the general principle, that wires (group of wires) leading different signals should be led in the highest possible distance between them (not less than 50 cm) and the crossover of such groups of wires made at a right angle (90°).

4. PRINCIPLE OF MR03 MODULE OPERATION

The MR03 radio transmission module enables the radio communication of devices equipped in an RS-232 or RS-485 serial port and USB converter into RS-232 or RS-485, e.g. PD10 or PD12 type. The communication with RS-232 or RS-485 interface can be carried out at rates from 4800 bits to 115.2 kbits.

The radio transmission is realized in the shape of data packages. The module allows to transmit data of maximal length, 1024 bytes. The data transmission is carried out in following way: data bits are collected from the serial port and are rewritten to the reception buffer. After an appropriate time ("time out") from the transmission end, placed data in the buffer are prepared to be transmitted on radio links. In order to transmit

data, frames are created, the structure of which depends on the selected working mode.

The radio module can work in the “point-to-many points” mode (data are sent from one module and are received by all modules being in the range) or in the “point-to-point” mode, where data are sent to a define device. Data of the package heading, including necessary information for data exchange are additionally protected by CRC checksum.

Data received from the serial interface during the radio transmission are not protected by the checksum. The reception of radio data consists on the reception of transmitted packages and their transmission to the output buffer of the serial interface. The reception module verifies the CRC checksum of the heading during the reception.

After the heading reception and verification of its contents in accordance to the set working mode, data are sent in the serial interface. If a CRC error is discovered, the package is not received. In the case of point-to-point working mode, data originating from the same sender are transmitted in the serial interface. The current module work state is signaled by lighting diodes: RxD and TxD diodes signals the flow of data through the transmission radio channel.

If after the module supply switching on, the lighting sequence of each module follows, ended by the continuous lighting of the green PwR diode, then this atests about the initialization of the standard module work with a correct configuration. The lighting of all diodes means that the module is in the expectation state before the configuration. The configuration is carried out by means of the MR03Config.exe. configuration program. The configuration program takes advantage of one of the accessible computer serial port and the module MR03.

To switch the MR03 module in the configuration mode, one must press during three seconds (till the lighting of all diodes) SW1 push on the plate and the place indicated on the fig.3. In that moment, the MR03 module breaks the normal work and transits to the expectation state for the connection with the configuration program and admits appropriate settings of its serial port (9600, 8N1).

After the configuration change, one must make the module reset through the switching of the supply voltage off or by giving the command “Reset the module” from the configuration program. The module restart in the standard mode with new settings.

The module is configured by the manufacturer to operate in the serial port with the rate 9600 bit/s in the 8N1 mode and “point-to-many points” mode.

Default module parameters can be restored without the use of the configuration program. For this aim, one must:

1. switch the module supply off,
2. press the SW1 push and holding it pressed, switch the module supply on,
3. release the SW1 push after 6 sec. (after the time of a quick extinction and lighting of diodes, and the automatic module reset – what means the charge of new parameters.

4.1. First start of the MR03 module

At the first start, the MR03 module requires the setting of following parameters: module working mode, signal power and channel number for the radio transmission. Moreover, it is indispensable to set serial port parameters: rates and transmission mode.

The added “MR03Config.exe.” program to the module set allows the user to configure the MR03 radio module in an easy and simple way.

4.1.1. Installation of the configuration program on a PC

The installation relies on copying “MR03Config.exe.” program files from the added CD to the module set into the catalog assigned by the user on the computer hard disk.

The program can be also started directly from the CD.

The “MR03Config.exe.” program is destined to work on systemic platforms Windows 2000, XP.

4.1.2. Procedure of MR03 module configuration

In order to configure the MR03 module, one must connect it to the computer serial port: RS-232, RS-485 or USB converter e.g. PD10 or PD12 type, acc. to fig 4 and 5, and next switch the module supply on. To introduce the module in the expectation state to the configuration, one must press and hold the SW1 push during three seconds (till the lighting time of all diodes). Next, one must start the “MR03Config.exe.” program and

choose the appropriate type of the radio module from the “Configuration” menu (see fig. 6).

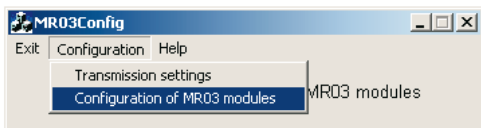

Fig.6. View of the main window of the MR03 configuration program

After opening the confirmation window, one must select the serial port number and read out data from the module through the “Connect/read out data” key. – fig. 7.

After the correct readout of settings, all setting fields are unlocked.

In case of any connection loss, configuration fields are locked.

The configuration program writes settings in the module after every change of optionally selected options.

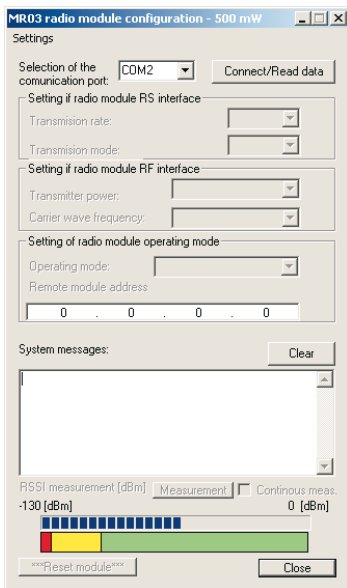

Fig. 7.
View of the window configuring the MR03 module

Following options are accessible:

- serial port options:
 - serial transmission rate (4800...115000 bit/s)
 - serial transmission mode (8N1, 8N2, 8E1, 8O1, 7E1, 7O1),
- radio port options:
 - module operating mode,
 - 5 transmission channels,
 - 4 power levels.

In order to restore default settings, one must start the “MR03Config.exe.” program and select the suitable radio module from the “Configuration “ menu (fig.6). Next, choose “manufacturer’s settings of the RF module” from the “Settings” --> menu – fig. 8.

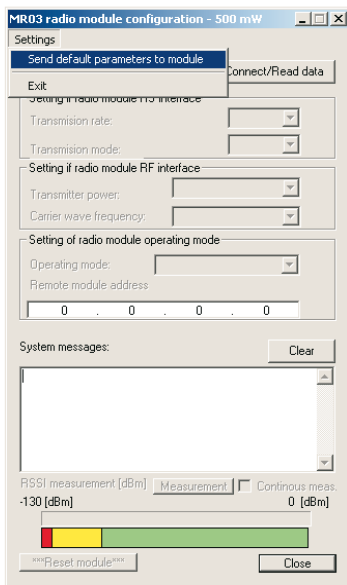

Fig. 8. selection of the default parameter setting function

Each setting change is registered in the message window of the “MR-03Config.exe.” program . In case of a correct or erroneous operation of setting change, an appropriate message is displayed in the message window.

4.1.3. Way of the received power signal measurement - RSSI

In order to perform the signal measurement in the radio channel , one must start the “MR03Config.exe.” program and choose the suitable module radio type from the “Configuration “ menu, what will cause the window opening (fig.7). Next, connect the radio module acc. to the section 4.1.2.

In further sequence, bring about that the device will receive data originating from other radio modules. The release of measuring readout is carried out through the “Measurement” push or by switching the “continuous measurement “ function on (fig.10). For this operating mode, the signal power readout is performed every 3 seconds.

If data package is not received in the radio interface, then the measurement is not possible, whereby we obtain information “RSSI: Lack” (fig.9). in the message window of the configuration program.

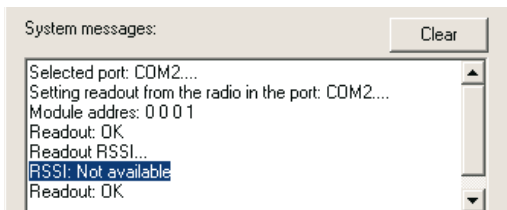

Fig. 9. Display way of the signal measurement lack received in the radio channel

If data are received in the radio interface, then the module after the package reception carries out the signal power measurement and after questioning by the configuration program, sends the value to the PC computer. The result is presented in the message window and in the graphic shape on the progress bar – fig. 10.

After reading out the power value, the radio module expects the successive package, allowing the renewed measurement of the RSSI signal.

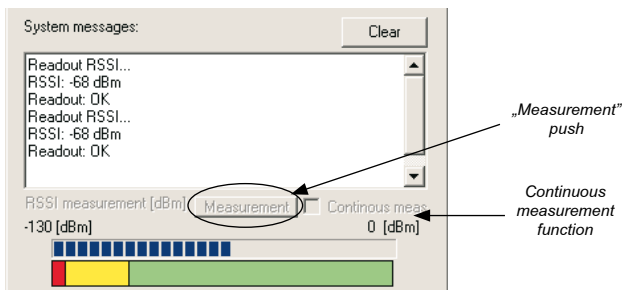

Fig. 10. Display way of the signal power level received in the radio channel

4.1.4. List of errors displayed in the system window

List of errors MR03Config program

Table 3

Error message	Error description
Readout: ERROR 01	Error of the programming/confirming function
Readout: ERROR 02	Error of the configured device address
Readout: ERROR 03	Data error, CRC error
Write: ERROR 11	Error of data write
Write: ERROR 12	Error of data write
RS port: ERROR 21	Error of serial interface for connection/readout of all data from the module.
RS port: ERROR 22	Error of serial interface for the setting of the serial port rate
RS port: ERROR 23	Error of serial interface for the setting of the operating mode
RS port: ERROR 24	Error of serial interface for the setting of the transmitter power
RS port: ERROR 25	Error of serial interface for the setting of the radio channel frequency
RS port: ERROR 26	Error of serial interface for the setting of the radio module operating mode
RS port: ERROR 27	Error of serial interface for the setting of the module address for the point-to-point mode
RS port: ERROR 28	Error of serial interface for the readout of the RSSI value
RS port: ERROR 29	Error of serial interface for manufacturer's parameter settings
Connection: ERROR 31	No answer from the radio module

4.1.5. Prescription concerning radio transmission or sending-receiving devices which can be used without permission.

In accordance with the ordinance of the Infrastructure Minister of the 6 th August 2002 – The Journal of Law nr 138, item 1162, defines the transmitter activity term.

The transmitter activity is defined by the transmitter activity coefficient – we understand by that the proportional transmission time relation in one or many carrier frequencies to the device operation time in 1 hour' period.

For the frequency of the MR03 radio module (869.4 MHz – 869.65 MHz) a large transmission activity has been assigned. It is the activity for which:

- The transmission efficiency coefficient is higher than 1% and lower than 10%
- The maximal transmission connection time is equal 36 seconds
- The minimal transmitter disconnection time is equal 3.6 seconds.



The conformity with the above ordinance must be obtained on the level of the transmitting-receiving system.

The manufacturer does not be responsible for the use of radio modules inconsistently with the above ordinance on the Polish territory or with other ordinances proper for the operational use place.

5. TECHNICAL DATA

Serial port:

- RS-232 interface
 - data format 8N1, 8N2, 8E1, 8O1, 7E1, 7O1
 - baud rate 4800 - 115200 bit/s
- RS-485 interface
 - data format 8N1, 8N2, 8E1, 8O1, 7E1, 7O1
 - baud rate 4800 - 115200 bit/s

Radio channel:

- carrier frequency	869.4... 869.65 MHz
- power	500 mW, 250 mW, 125 mW, 40 mW
- sensitivity of the receiver	>103 dBm
- baud rate	4800 bit/s
- transmission range in a right line (open area)	1500 m
- number of channels	5
- antenna output	50 Ω SMA

Time to obtain the operating readiness since the moment of supply connection

≤ 2s

Maximal delay time of transmission by a pair of MR03 modules

1.5 s (when transmitting 512 B data)

Power absorbed by the module ≤ 5 VA**Rated operating conditions:**

- supply voltage	8... 30 V a.c./d.c.
- ambient temperature	- 20... <u>23</u> ...55°C
- relative air humidity	< 95% inadmissible condensation
- working position	any

Storage and transport conditions:

- ambient temperature	- 40... 70°C
- relative air humidity	< 95% inadmissible condensation

Ensured protection degree by the housing:

- from the frontal housing side	IP 54
- from the terminal side	IP 54

Dimensions

115 × 65 × 40 mm
(without the mounted antenna)

Weight

400 g

Housing self-extinguishing

Electromagnetic compatibility:

- noise immunity EN 301 489-1 V1.2.1 p. 7.1 i 8
- emission of radio noise EN 301 489-1 V1.2.1 p. 7.2 i 9

Safety requirements acc. to EN 60215 standard

- installation category III
- pollution degree 2
- maximal voltage in relation to earth 50V



6. MR03 ORDER CODES

MR03 high power transmission module	XX	X
Kind of version:		
catalog	00	
custom made *	XX	
Acceptance tests:		
without an extra quality inspection certificate		8
with an extra quality inspection certificate		7
acc. to user's agreement *		X

* after agreeing by the manufacturer

CODING EXAMPLE

The **MR03-00-7** code means:

- 00** – MR03 module acc. to the catalog
- 7** – with a quality inspection certificate

7. MAINTENANCE AND WARRANTY

The MR03 high power radio transmission module does not require any periodical maintenance.

In case of some incorrect operations:

1. In the period of 12 months from the date of purchase:

One should take the modul down from the installation and return it to the Manufacturer's Quality Control Dept.

If the unit has been used in compliance with the instructions, the Manufacturer warrants to repair it free of charge.

2. After the warranty period:

One should turn over the module to repair it in a certified service workshop.

The disassembly of the housing causes the cancellation of the granted warranty.

Our policy is one of continuous improvement and we reserve the right to make changes in design and specifications of any products as engineering advances or necessity requires and revise the above specifications without notice.

SALES PROGRAMME

- DIGITAL and BARGRAPH PANEL METERS
- MEASURING TRANSDUCERS
- ANALOG PANEL METERS (DIN INSTRUMENTS)
- ANALOG and DIGITAL CLAMP-ON METERS
- PROCESS and HOUSEHOLD CONTROLLERS
- CHART AND PAPERLESS RECORDERS
- POWER CONTROL UNITS and SOLID-STATE RELAYS
- AUTOMOTIVE DASHBOARD INDICATORS
- 1-PHASE AND 3-PHASE WATT-HOUR METERS
- NUMERICAL AND ALPHANUMERICAL LARGE SIZE DISPLAYS
- ACCESSORIES FOR MEASURING INSTRUMENTS (SHUNTS AND MODULES)
- MEASURING SYSTEMS (ENERGY, HEAT, CONTROL)
- CUSTOM-MADE ELECTRONIC SUBASSEMBLIES ACC. TO ORDERS

WE ALSO OFFER OUR SERVICES IN THE PRODUCTION OF:

- ALUMINIUM ALLOY PRESSURE CASTINGS
- PRECISION ENGINEERING AND THERMOPLASTICS PARTS
- PRESSURE CASTING DIES AND OTHER TOOLS
- CUSTOM-MADE ELECTRONIC SUB-ASSEMBLIES

QUALITY PROCEDURES:

According ISO 9001 and ISO 14001 international requirements.

All our instruments have CE mark.

For more information, please write to or phone our Export Department.



Lubuskie Zakłady Aparatów Elektrycznych LUMEL S.A.

ul. Sulechowska 1

65-022 Zielona Góra - Poland

tel.: (48-68) 329 51 00 (exchange)

fax: (48-68) 329 51 01

e-mail: lumel@lumel.com.pl

<http://www.lumel.com.pl>

**MEASUREMENT
CONTROL
RECORDING**

Export Department:

Tel.: (48-68) 329 53 02 or 53 04

Fax: (48-68) 325 40 91

e-mail: export@lumel.com.pl